

CANDIDATE
NAME

CENTRE
NUMBER

--	--	--	--	--

CANDIDATE
NUMBER

--	--	--	--

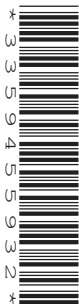

PHYSICS

0625/63

Paper 6 Alternative to Practical

October/November 2016

1 hour

Candidates answer on the Question Paper.

No Additional Materials are required.

READ THESE INSTRUCTIONS FIRST

Write your Centre number, candidate number and name on all the work you hand in.

Write in dark blue or black pen.

You may use an HB pencil for any diagrams or graphs.

Do not use staples, paper clips, glue or correction fluid.

DO NOT WRITE IN ANY BARCODES.

Answer **all** questions.

Electronic calculators may be used.

You may lose marks if you do not show your working or if you do not use appropriate units.

At the end of the examination, fasten all your work securely together.

The number of marks is given in brackets [] at the end of each question or part question.

The syllabus is approved for use in England, Wales and Northern Ireland as a Cambridge International Level 1/Level 2 Certificate.

This document consists of **12** printed pages.

- 1 Some students are investigating how the surface area of water exposed to the air affects the rate at which the water cools.

They are using the apparatus shown in Fig. 1.1. Beaker **B** is bigger than beaker **A**.

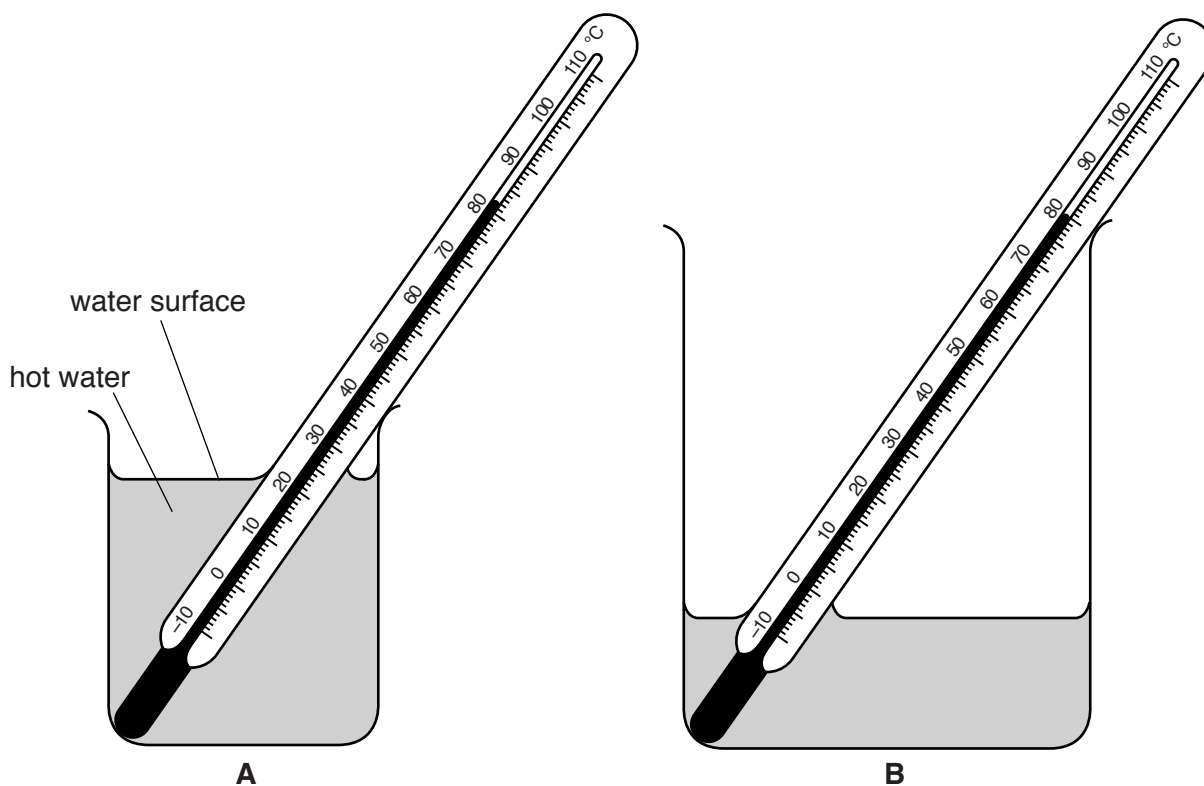

Fig. 1.1

- (a) The students pour 75 cm^3 of hot water into beaker **A** and 75 cm^3 of hot water into beaker **B**. They immediately start a stopclock.
- (i) Record, in the first row of Table 1.1, the initial temperatures θ of the water in beaker **A** and in beaker **B**, as shown in Fig. 1.1. [1]
- (ii) The students record the temperatures θ of the water every 30s. Their readings are shown in Table 1.1.

Complete the headings and the time t column in Table 1.1.

[2]

Table 1.1

	beaker A	beaker B
$t/$	$\theta/$	$\theta/$
0		
	80.0	76.0
	78.0	73.5
	76.5	71.0
	75.0	68.5
	73.5	66.5
	72.5	65.0

(b) Describe two precautions which should be taken, when using this apparatus, to ensure that the temperature readings are as reliable as possible in the experiment.

1.

.....

2.

.....

[2]

(c) (i) Write a conclusion, stating how increasing the surface area of the hot water affects the rate of cooling of the water. Justify your answer by reference to the results.

.....

.....

.....

.....[2]

- (ii) Suggest a change to the apparatus to make the comparison of the effect of surface area on cooling a fairer test.

Explain why the change is an improvement and state the likely effect on the recorded temperatures.

change

.....

explanation

.....

effect on temperatures

.....

[3]

- (d) Students in other classrooms are carrying out the same experiment.

Suggest a factor that they should keep the same if they are all to obtain similar temperature readings.

.....

.....[1]

[Total: 11]

- 2 Some students are determining the focal length of a converging lens by two different methods. They are using the apparatus shown in Fig. 2.1.

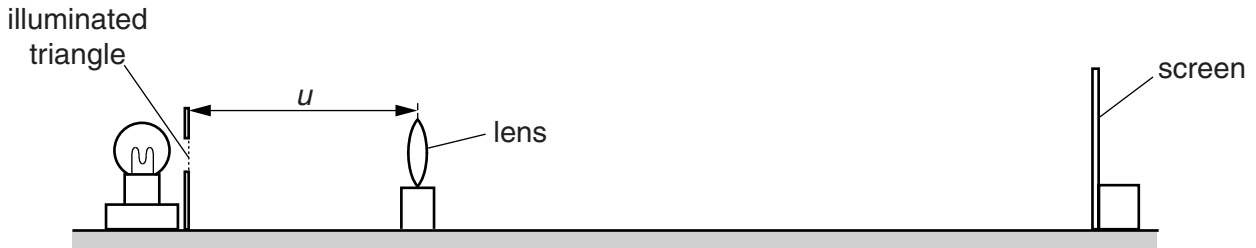

Fig. 2.1

- (a) A student sets the distance u between the illuminated triangle and the lens to 20.0 cm. She moves the screen until a sharp image of the triangle is seen on the screen.

- (i) • Measure h_o , the height of the illuminated triangle, as shown in Fig. 2.2.

$h_o = \dots\dots\dots$

- Measure h_I , the height of the image on the screen, as shown in Fig. 2.3.

$h_I = \dots\dots\dots$ [2]

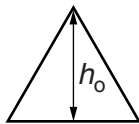

Fig. 2.2

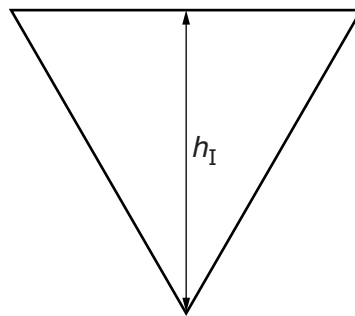

Fig. 2.3

- (ii) Calculate a value M for the magnification, using the equation $M = \frac{h_I}{h_o}$.

$M = \dots\dots\dots$ [1]

- (iii) Calculate a value for the focal length f_1 of the lens, using the equation $f_1 = \frac{uM}{(M + 1)}$, where $u = 20.0$ cm.

$f_1 = \dots\dots\dots$ [2]

- (iv) Describe one difficulty that might be experienced when measuring the height of the image. Suggest an improvement to the apparatus to overcome this.

difficulty

.....

improvement

.....

[2]

- (b) The student adjusts the position of the lens so that $u = 40.0$ cm.

She moves the screen until a sharp image of the triangle is again seen on the screen. Fig. 2.4 is a scale diagram showing her result.

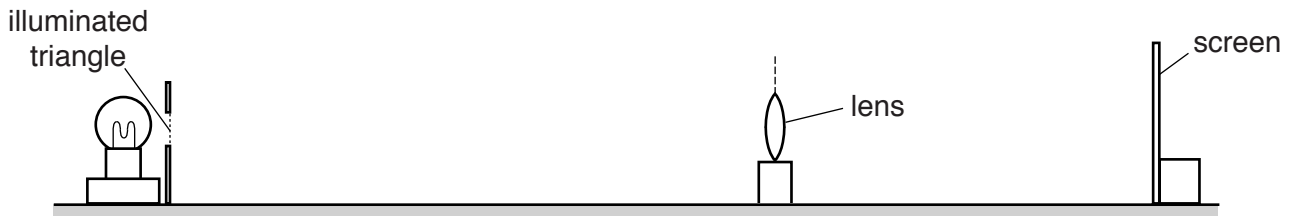

Fig. 2.4

- (i) • On Fig. 2.4, measure the distance between the lens and the screen.

distance =

- Fig. 2.4 is drawn to 1/5th scale.

Determine the actual distance v between the lens and the screen in the experiment.

$v =$

[1]

- (ii) • Calculate a second value f_2 for the focal length of the lens, using the equation

$$f_2 = \frac{uv}{(u+v)}, \text{ where } u = 40.0 \text{ cm.}$$

$$f_2 = \dots\dots\dots$$

- The student suggests that f_1 and f_2 should be equal.

State whether the results support this suggestion. Justify your statement with reference to the results.

.....

[2]

- (c) State one precaution, not included in your answer to (a)(iv), that you would take to make the experiment reliable.

.....
[1]

[Total: 11]

3 A student is investigating the resistance of a lamp.

He is using the circuit shown in Fig. 3.1.

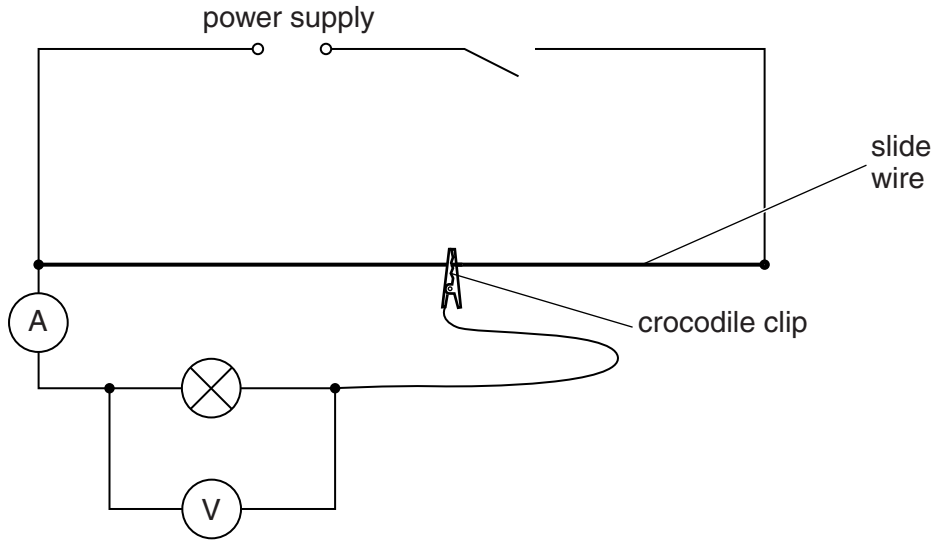

Fig. 3.1

(a) The student connects the crocodile clip on the slide wire to give particular values of the potential difference V across the lamp. He measures the current I in the lamp for each position.

Figs. 3.2 to 3.6 show the ammeter readings for values of $V = 0.5\text{V}$, 1.0V , 1.5V , 2.0V and 2.5V , respectively.

Read, and record in Table 3.1, the value of I for each value of potential difference V . Record each value to 2 significant figures.

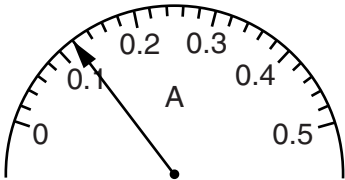

Fig. 3.2

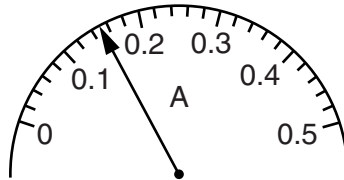

Fig. 3.3

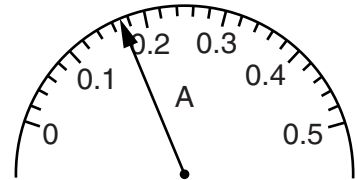

Fig. 3.4

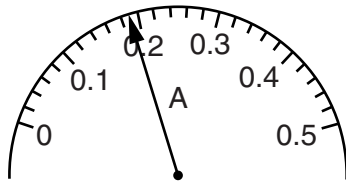

Fig. 3.5

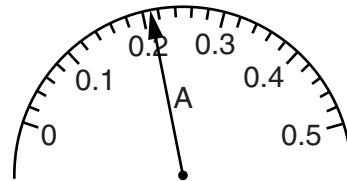

Fig. 3.6

[2]

- (b) Calculate, and record in Table 3.1, the resistance R of the lamp at each value of V .

Use the equation $R = \frac{V}{I}$.

[1]

Table 3.1

V/V	I/A	R/Ω
0.5		
1.0		
1.5		
2.0		
2.5		

- (c) Plot a graph of R/Ω (y -axis) against V/V (x -axis).

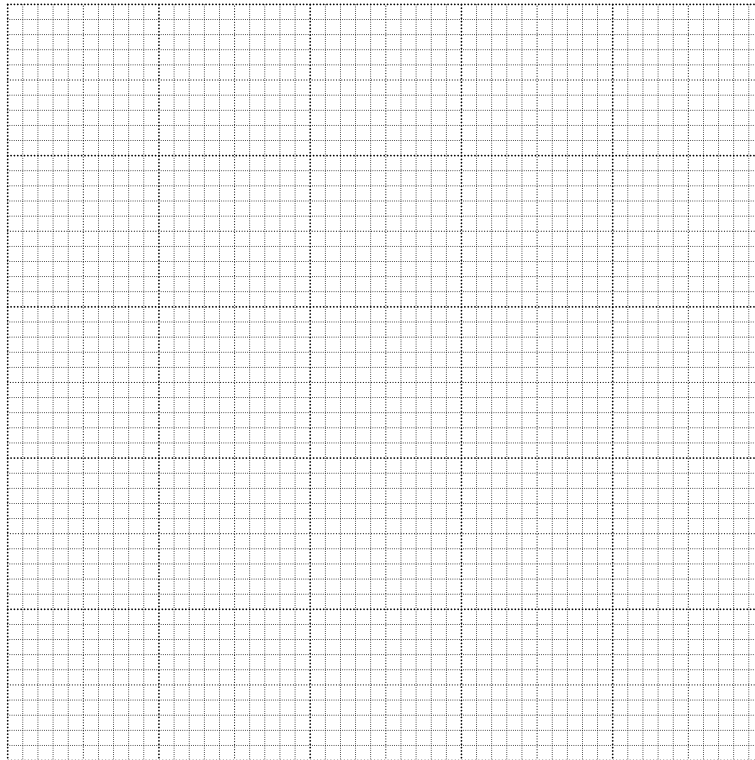

[4]

- (d) State what the shape of the graph tells you about the change, if any, in the resistance of the lamp during the experiment.

.....

.....

.....

..... [2]

- (e) In this type of experiment, it is possible to change the current and potential difference for the lamp by using a variable resistor rather than a slide wire.

On Fig. 3.7, complete the circuit diagram to show a variable resistor used for this purpose.

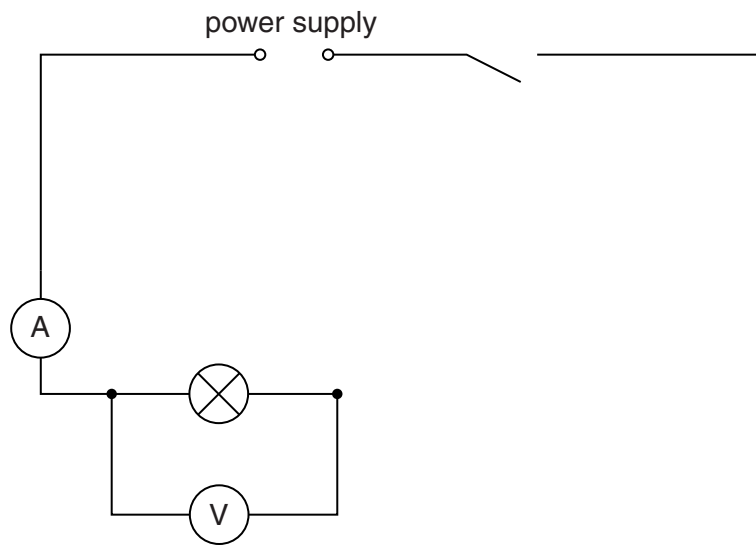

Fig. 3.7

[2]

[Total: 11]

- 4 A student has noticed that different types of paper have different strengths.

Plan an experiment which will enable you to compare the strengths of different samples of thin paper, prepared as shown in Fig. 4.1.

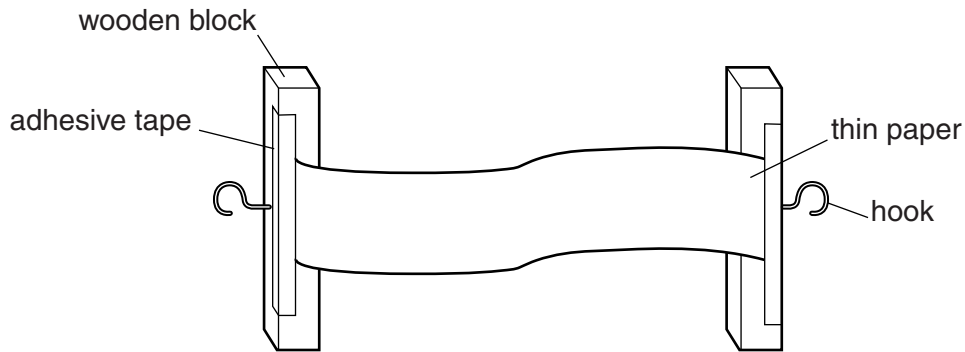

Fig. 4.1

Write a plan for the experiment, including:

- the additional apparatus needed
- instructions for carrying out the experiment, including any precautions you will take
- what you will measure
- how you will present your results
- how you will determine which paper is the strongest
- the variables you will keep the same to ensure the comparison is a fair test.

You may draw a diagram if it helps to explain your plan.

.....

..... [7]

[Total: 7]

Permission to reproduce items where third-party owned material protected by copyright is included has been sought and cleared where possible. Every reasonable effort has been made by the publisher (UCLES) to trace copyright holders, but if any items requiring clearance have unwittingly been included, the publisher will be pleased to make amends at the earliest possible opportunity.

To avoid the issue of disclosure of answer-related information to candidates, all copyright acknowledgements are reproduced online in the Cambridge International Examinations Copyright Acknowledgements Booklet. This is produced for each series of examinations and is freely available to download at www.cie.org.uk after the live examination series.

Cambridge International Examinations is part of the Cambridge Assessment Group. Cambridge Assessment is the brand name of University of Cambridge Local Examinations Syndicate (UCLES), which is itself a department of the University of Cambridge.